



Edelbrock E-Force Supercharger

2012-2017 SRT/SRT8 Jeep 6.4L HEMI

Part #15354, 15356 & 153560



WARNING!

The supercharger bypass valve is factory installed and adjusted intended to be vacuum operated only. DO NOT move the solenoid actuator lever by hand or adjust the stop point. Moving the lever manually will damage the solenoid and the system will not function properly. Damage to the bypass assembly from manual movement will not be covered under manufacture warranty.

IMPORTANT CALIBRATION DETAILS



2015-2017 Vehicles ONLY

USA CUSTOMERS ONLY:

In order to properly calibrate your vehicle for this supercharger kit, the ECM must be removed from the vehicle, packaged and shipped to Edelbrock. Your vehicle's computer will be modified and or flashed for supercharger kit compatibility. This kit contains a box for shipping the ECM to Edelbrock. (See ECM removal procedures on the following page.)

NOTE: *Please email your Name, Address, phone number and email address to ECMCalibration@Edelbrock.com and a prepaid return label will be sent. Affix the label to the package and drop it off at any UPS Store in your area.*

The calibration process will take up to 5 business days from the time your vehicles computers are received. To avoid unplanned vehicle down time, we recommend that the computers be shipped out BEFORE beginning the supercharger installation.

INTERNATIONAL (NON-USA) CUSTOMERS PLEASE CALL EDELBROCK TECHNICAL SUPPORT AT (800)-416-8628.

ECM Removal

The ECM is located under the hood on the passenger side of the vehicle. Follow these instructions carefully to remove, package and ship the ECM to Edelbrock.

1. Disconnect the positive battery terminal located on the passenger side fire wall and isolate the cable so it does not come in contact with the terminal or body of the vehicle.



2. Push in the black locking tab and lift up the red clasps on the ECM harness connectors and remove them from the ECM.

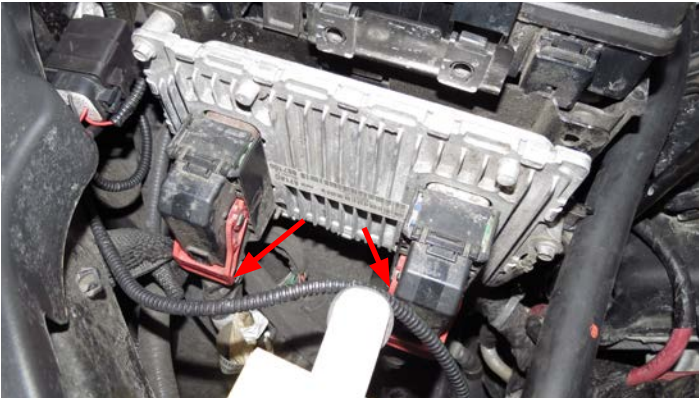

3. Using an 8mm socket, remove the three (3) bolts securing the ECM to its bracket.



4. Fill out the provided calibration label with customer and vehicle information and apply the label directly to the ECM. Place the ECM in the provided box with packing material so the ECM cannot move around in the box. Ship ECM to Edelbrock using the provided return shipping label.



Edelbrock E-Force Supercharger System 2012-2017 SRT Jeep 6.4L Hemi

Installation Instructions

2012-2014 VEHICLES ONLY: PLEASE COMPLETE THIS PROCEDURE PRIOR to starting the installation of your E-Force supercharger system. This will allow our calibration team to complete your calibration file while the installation of your supercharger system is being completed. Manufacturers regularly update the factory calibration, as a result, there is the possibility for delays due to not having access to your current calibration file. This can normally be resolved in 1 business day.

FAILURE TO PROVIDE ALL OF THE INFORMATION BELOW WILL DELAY THE COMPLETION OF THE CALIBRATION FILE FOR YOUR VEHICLE. TO LIMIT VEHICLE DOWN TIME, PLEASE SEND US THE REQUESTED INFORMATION BEFORE STARTING THE SUPERCHARGER INSTALL.

Please e-mail the requested information below to calibration@edelbrock.com with the E-mail Subject as "Calibration Update". We will complete your calibration and e-mail it back to you as soon as possible. MOST calibration updates will be sent back the same business day. In rare cases, it could take up to 1-2 business days to complete. Please contact our Tech Hot Line at (800)416-8628 if you have any questions or if you need assistance with this procedure.

INFORMATION NEEDED:

- | | |
|--|----------------------------------|
| E-Mail Address: | Fuel Octane (91 or 93 ONLY): |
| Vehicle Year: | Supercharger System Part Number: |
| Vehicle Make: | Supercharger Serial Number: |
| Vehicle Model (Specify if Z06, Z51, SRT8, RT, Boss 302, etc.): | Programmer Serial Number: |
| Engine Size: | ECU OS Part Number: |
| Transmission: | ECU OS Part Type: |

INSTRUCTIONS FOR GETTING THE ECU OS PART NUMBER & TYPE:

With the ignition OFF, connect the supplied SCT X4 Programmer to the OBDII port of the vehicle using the cable included with the SCT programmer.

Once the SCT programmer powers on, it will take you to the Main Menu. Press the down arrow to highlight the "Vehicle Info" option and press the round center button to accept.

Follow the on-screen instructions. When prompted to do so, turn the vehicle's ignition ON but do not start the engine. Press the round center button to accept. The ECU OS Part Number and Type will be displayed on the following screen.

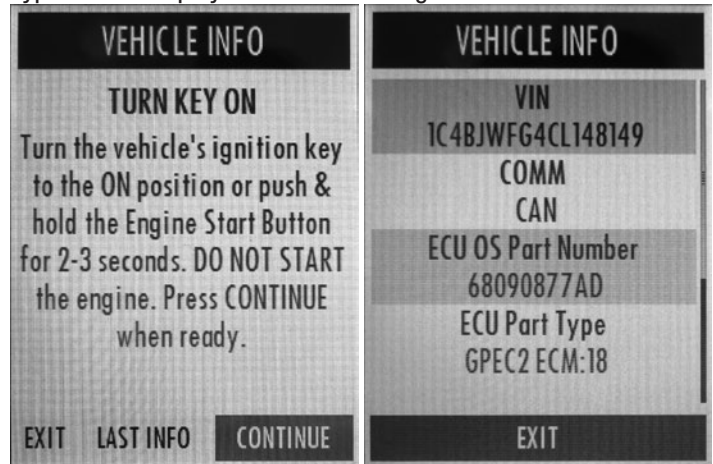



INTRODUCTION

Thank you for purchasing the Edelbrock Supercharger System for SRT/SRT8 Jeeps with 6.4L Hemi Engine. The Edelbrock E-Force Supercharger System utilizes Eaton's R2650 TVS Supercharger rotors, featuring a four-lobe design with 170° of twist. The Edelbrock Supercharger is a complete system that maximizes efficiency and performance by minimizing air restriction into, and out of, the supercharger. This results in maximum airflow with minimal temperature rise and power consumption. The supercharger housing itself is integrated into the intake manifold for a seamless design with minimal components. The system also utilizes a front drive, front inlet configuration giving it the shortest, least restrictive inlet path on the market.

The supercharger is inverted, expelling the air upward. Air pressure then builds in the plenum before being pushed twice through the dual pass, 3-Core intercooler that is oriented horizontally, above the supercharger outlet. After passing through the intercooler core, the air travels through the runners which route straight down into the cylinder head ports. This configuration allows for a compact package that fits under the stock hood and cowl of the vehicle for which it was designed without sacrificing intercooler area. The end result is a supercharger that provides neck snapping performance that is safe to operate on a completely stock engine.

TOOLS AND SUPPLIES REQUIRED

- Jack and Jack Stands OR Service Lift
- Panel Puller
- Ratchet and Socket Set including: 7mm, 8mm, 10mm (standard, deep and swivel), 11mm, 12mm (deep), 13mm, 15mm, 18mm, 21mm (deep), 24mm
- Wrenches including: 8mm, 18mm, 27mm
- 1/2" Breaker Bar
- Flat & Phillips Screwdrivers
- Compressed Air
- 90° Power Drill
- Allen Wrenches including: 1/4", 5mm, 6mm, 8mm
- Side Cutters
- Dremel
- 3/8" Fuel Line Removal Tools
- Torque Wrench
- Needle Nose Pliers
- Pliers OR Hose Clamp Removal Tool
- Impact Wrench
- Blue & Green Loctite Retaining Compound or equivalent
- O-ring Lube
- Masking Tape
- Electrical Tape
- Zip Ties



IMPORTANT WARNINGS

Before beginning installation, use the enclosed checklist to verify that all components are present in the box then inspect each component for damage that may have occurred in transit. If any parts are missing or damaged, contact Edelbrock Technical Support (800-416-8628), not your parts distributor.



WARNING: Installation of this supercharger will result in a significant change to the performance characteristics of your vehicle. It is highly recommended that you take some time to familiarize yourself with the added power, and how it is delivered, in a controlled environment. Take extra care on wet and slippery roads, as the rear tires will be more likely to lose traction, with the added power. It is never recommended to turn off your vehicles traction control system.

Proper installation is the responsibility of the installer. Improper installation will void all manufacturer's standard warranties and may result in poor performance and engine or vehicle damage.

Inspect all components for damage that may have occurred in transit before beginning installation. If any parts are missing or damaged, contact Edelbrock Technical Support, not your parts distributor.

Due to the complexity of the Edelbrock E-Force Supercharging system, it is recommended that this system only be installed by a qualified professional with access to a service lift, pneumatic tools, and a strong familiarity with automotive service procedures. To qualify for the optional supplemental warranty, it is necessary to have this system installed by a Certified ASE Technician at a licensed business, Dodge/Chrysler Dealership, or an Authorized Edelbrock Installer. Failure to do so will void and/or disqualify any and all optional supplemental warranties offered with this system. Please contact the Edelbrock Technical Support department if you have any questions regarding this system and/or how your installer of choice will affect any warranty coverage for which your vehicle may qualify.

Any previously installed aftermarket tuning equipment must be removed and the vehicle returned to an as stock condition before installing the supercharger.

Any equipment that directly modifies the fuel mixture or ignition timing of the engine can cause severe engine damage if used in conjunction with the Edelbrock E-Force Supercharger System. This includes, but is not limited to: OBDII programmers, MAF sensors, adapters and any other device that modifies signals to and/or from the ECU. Aftermarket bolt-on equipment such as underdrive pulleys or air intake kits will also conflict with the operation of the supercharger and must be removed prior to installation. Use of any of these products with the E-Force Supercharger could result in severe engine damage.



IMPORTANT WARNINGS cont'd



91 octane or higher gasoline is required at all times. If your vehicle has been filled with anything less, it must be run until almost dry and refilled with 91 or higher octane gasoline twice prior to installation.

Any failures associated with not using premium 91 octane gasoline or higher, will be ineligible for warranty repairs.

It is recommended that you check the Edelbrock Tech Center Website for any updates to this installation manual. Please refer to the lower right hand corner to verify that you have the latest revision of this installation manual before beginning the installation.

Tech Center: http://www.edelbrock.com/automotive_new/misc/tech_center/install/index.php

Edelbrock Authorized Installer Disclaimer

Authorized installers of Edelbrock products are independent companies over which Edelbrock has no right of control. Edelbrock LLC makes no claims regarding the abilities, expertise or competency of individual employees of any authorized installer. Each authorized installer is an independent company and makes its own independent judgments. Edelbrock LLC specifically disclaims any responsibility to any party including third parties for the actions, or the failure to act, of individuals, agents or a company authorized in the installation of Edelbrock LLC products.

INSTALLATION HARDWARE IDENTIFICATION GUIDE

(Parts Are Not To Scale)

BAG #1 - MANIFOLD HARDWARE				
Item	P/N	QTY.	Description	Torque Spec
1	36-4053	4	Bolt, Hex Flange, M6 x 40mm	N/A
2	36-1507	4	Bolt, Hex Flange, M6 x 16mm	N/A
3	36-1508	12	Bolt, Hex Flange, M6 x 30mm	8 ft/lbs
4	51-4093	1	Throttle Body O-Ring	N/A

(1x) - Throttle Body O-Ring (Included, but not shown)



BAG #2 - FEAD HARDWARE				
Item	P/N	QTY.	Description	Torque Spec
1	36-1559	1	M8 x 110mm Hex Flange Bolt	21 ft/lbs
2	36-1560	1	M8 x 100MM Hex Flange Bolt	21 ft/lbs
3	36-4029	1	M8 x 100 Socket Head Bolt	21 ft/lbs
4	36-4011	1	M8 x 25mm Hex Flange Bolt	18 ft/lbs
5	82-0120	1	M8 Washer	N/A

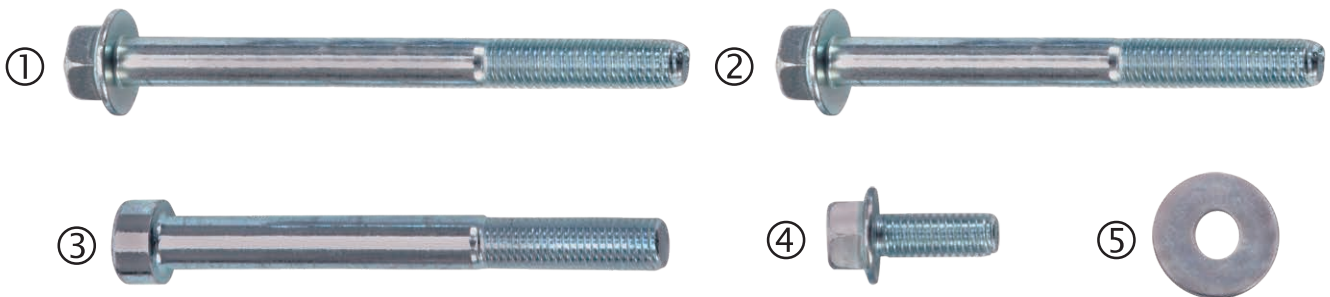

INSTALLATION HARDWARE IDENTIFICATION GUIDE, Con't

(Parts Are Not To Scale)

BAG #3 - INTERCOOLER HARDWARE				
Item	P/N	QTY.	Description	Torque Spec
1	36-1507	4	M6 x 16mm Hex Flange Bolt	N/A
2	36-1552	2	M6 x 10mm Hex Flange Bolt	N/A
3	46-2155	8	3/4" Hose Clamp	N/A
4	52-4199 52-4198	6 2	Push Pins - (2) Different Sizes (For fender liner reinstallation)	N/A



BAG #4 - DRILL/GUIDE HARDWARE				
Item	P/N	QTY.	Description	Torque Spec
1	36-4049	1	M14 x 1.5 x 100mm Bolt	N/A
2	51-7096	1	1/4" x 1/2" Dowel Pin	N/A
3	51-7046	1	15/64" Drill Bit	N/A
4	51-7047	1	.2500" Reamer	N/A
5	24-1591	1	Drill Fixture	N/A



HOSE IDENTIFICATION GUIDE

(Parts Are Not To Scale)



56-0006
Heat Exchanger
to Manifold

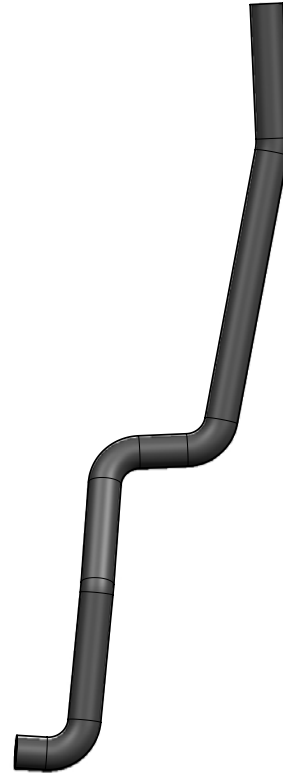

56-0004
Reservoir to
Water Pump

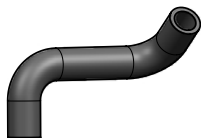

56-0005
Water Pump to
Heat Exchanger



22-4194
Driver Side PC



56-1578
Reservoir
to Manifold

INTERCOOLER BRACKET IDENTIFICATION GUIDE

(Parts Are Not To Scale)



38-0232
Passenger Side Upper



38-0230
Driver Side Upper

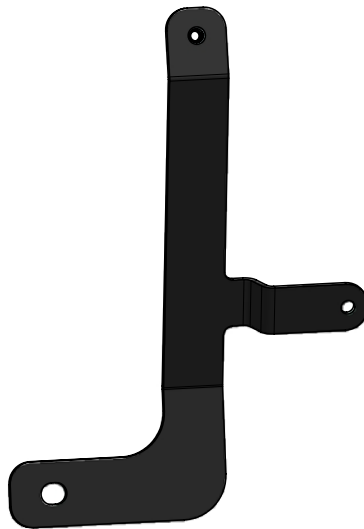

38-0233
Passenger Side Lower



38-0231
Driver Side Lower

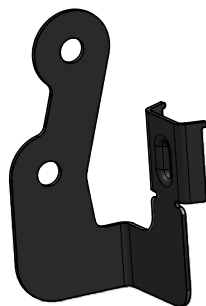

38-0234
Water Pump



38-0199
Surge Tank

HOSE ROUTING DIAGRAM

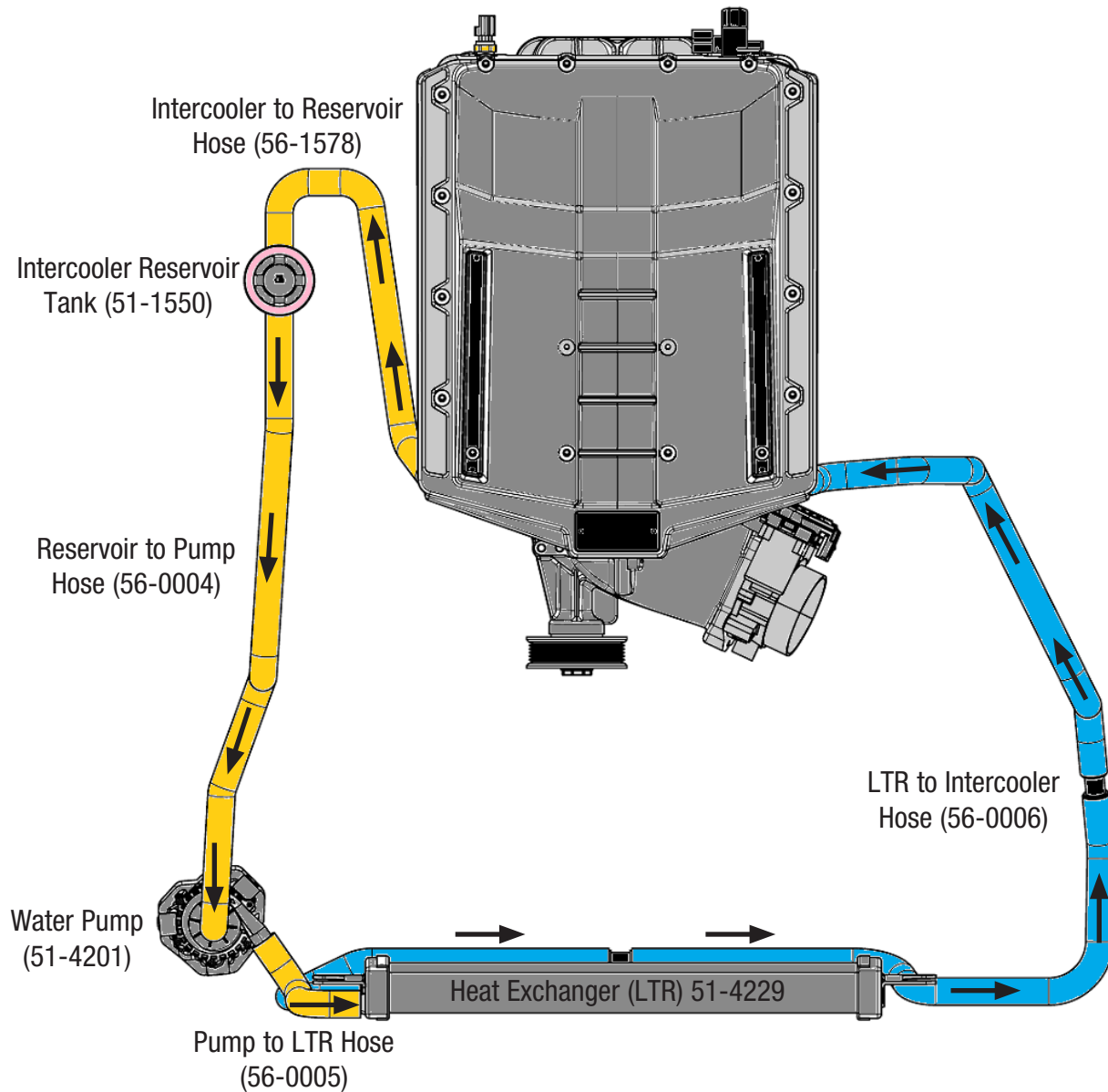

WIRE HARNESS IDENTIFICATION GUIDE

(Parts Are Not To Scale)

WIRE HARNESSES			
Item	P/N	QTY.	Description
1	37-6657	1	Map Sensor Harness
2	37-1913	1	Micro2 Fuse Tap
3	37-6655	1	IAT Extension Harness
4	37-1606	1	Water Pump Harness
5	37-6626	1	ECT Extension Harness
6	37-6631	1	Horn Extension Harness (Not Shown)



Supercharger Installation

This installation guide is intended to cover multiple vehicle model years. Depending on the vehicle year, images and procedures below may differ. If you have any questions call the **Edelbrock Tech line at (800)-416-8628**.

Steps 1-13 are for 2012-2014 vehicles only. 2015+ vehicles only need to reinstall the ECM upon being returned from Edelbrock. The computer has already been recalibrated for this supercharger system. After the computer is reinstalled, secure the provided OBDII "DO NOT FLASH" cover onto the OBDII port.

WARNING: Battery must be sufficiently charged before starting the ECM flashing procedure.

Only begin the ECM flashing procedure when you have downloaded the calibration file from the Edelbrock Calibration Team to the handheld programmer. Do not flash the ECM until you are ready to install the supercharger. Once the ECM is flashed, DO NOT START the engine until the installation of the E-Force supercharger is complete.

1. Put the vehicle into ACC mode, but don't start the engine.
2. Connect the supplied ECM cable on the handheld programmer to the OBD-II connector located below the steering wheel.
3. Use the directional pad to highlight the Program Vehicle option and press the Select button.

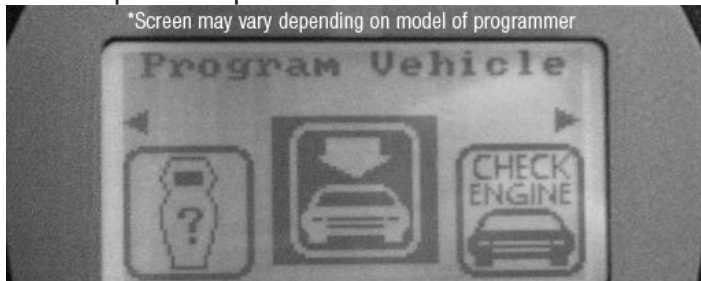

4. Use the directional pad to highlight the Pre-programmed Tune option and press the Select button.
5. Read the disclaimer then press Select to continue.

6. Verify that the ignition is in the 'Key On' position and that the engine is not running, then press Select.
7. Use the directional pad to highlight your vehicle and transmission combination then press Select.
8. Use the directional pad to highlight the Begin Program option then press Select.
9. Depending on your specific drivetrain configuration, several separate operations may take place during this step. Completion of each operation will cause the progress bar to reset to zero.
10. DO NOT unplug the programmer until prompted.

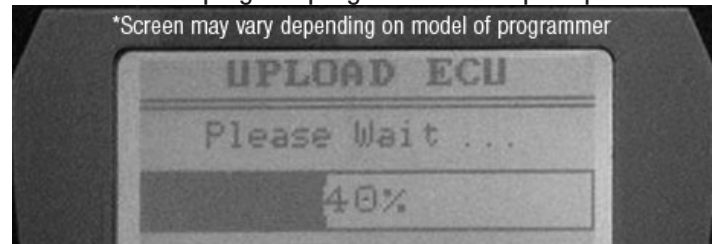

11. Turn the vehicle off when prompted to do so by the handheld programmer.
12. Read the parting message from programmer then press Select to continue.
13. Unplug the programmer cable from the OBD-II port. This concludes the ECM flashing procedure. DO NOT start the engine until the supercharger installation is complete.
14. Disconnect the positive (+) battery terminal located on the passenger side fire wall and isolate the cable so it does not come in contact with the terminal or body of the vehicle.

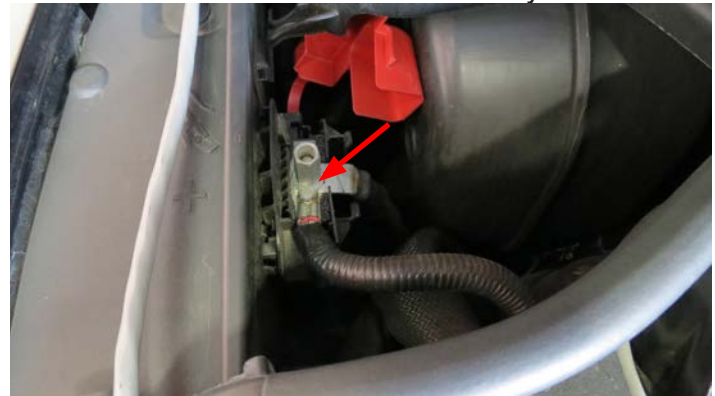

Installation Instructions

15. If applicable, reinstall the ECM by reversing the steps followed during removal. DO NOT reconnect the battery at this time. Install the included "Do Not Flash" cover onto the vehicle's ODBII port. **NOTE:** *If you are beginning the installation without the ECM present, go back to this step once the supercharger installation is complete.*

16. Raise the front of the vehicle with a service lift or equivalent and remove the front wheels.

17. Using a panel puller and Phillips Head screwdriver, remove the four (4) plastic rivets and four (4) screws securing the fender liner on both sides of the vehicle. **NOTE:** *Some vehicles will have permanent plastic rivets that must be cut and removed. Replacement rivets are included for reinstallation later.*



18. Using a panel puller and 10mm socket, remove the five (5) plastic push pins and four (4) bolts securing the front bumper to the lower shield.

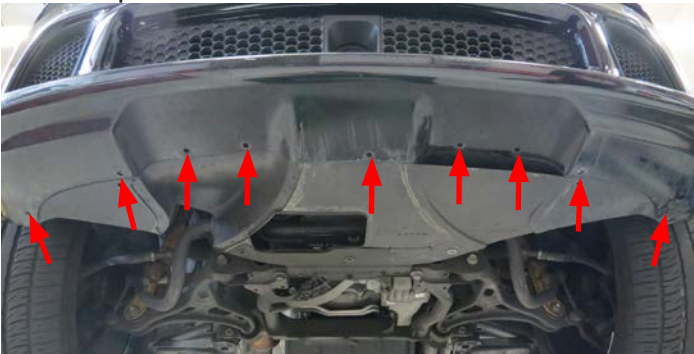

19. Lower the vehicle and remove the two (2) plastic push pins securing the radiator cover to the frame.



20. Pull back the fender liners and disconnect the lighting fixtures and parking sensors from the main harness. The driver side has two (2) lighting connectors and the passenger side has two (2) lighting connectors and one (1) main connection for the parking sensors.

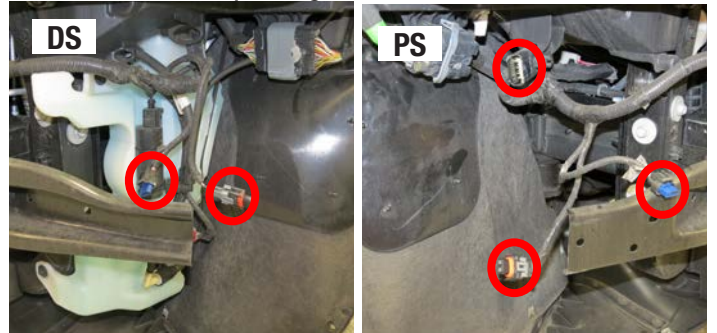

21. With the help from an assistant, remove the front bumper by pulling out on the top corners to disengage the plastic clips.



Installation Instructions

22. Raise the vehicle and disengage the three (3) twist locks and two (2) push pins securing the bumper support to the lower radiator support. Remove the bumper support and set aside.

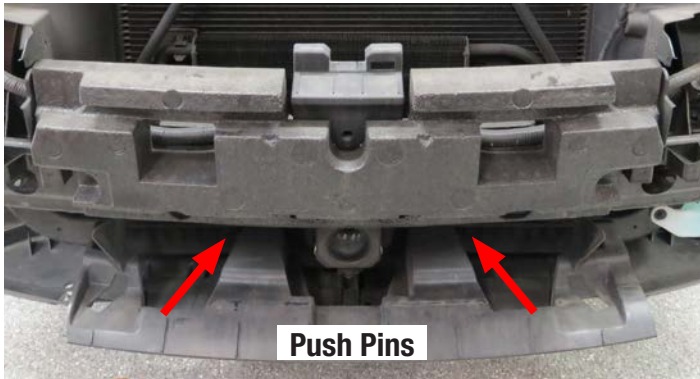
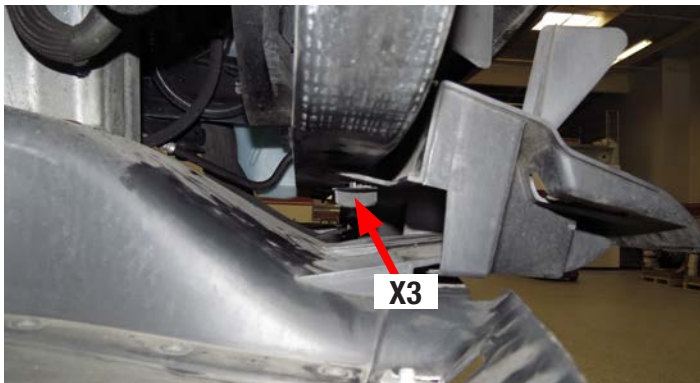

23. Remove the remaining five (5) bolts and one (1) push pin securing the lower shield and set aside.

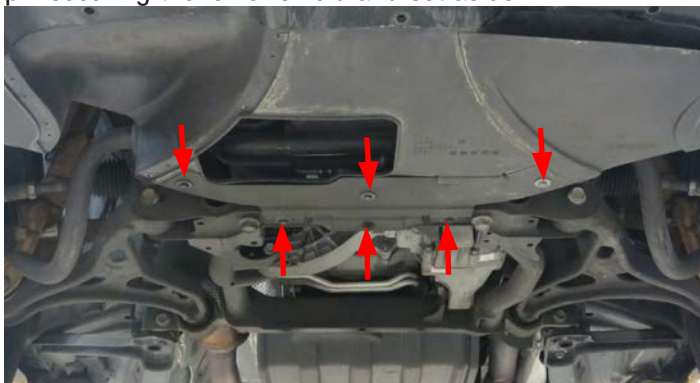

24. Place a drain pan below the petcock on the driver side of the radiator then loosen the petcock and drain the coolant. Reinstall petcock when radiator is drained.

25. Remove the decorative engine covers by firmly and evenly pulling them up and off of the mounting posts.



26. Remove the driver side PCV hose from the intake manifold. This hose will not be reused.



27. Loosen the worm clamps securing the air inlet tube to the throttle body and disconnect the engine harness from the IAT sensor. Remove the airbox and air inlet tube by pulling the airbox up and off of the mounting grommets.



Installation Instructions

28. Remove the hose from the nipple on the EVAP solenoid mounted behind the driver side cylinder head, then remove the hose from the front of the manifold. This hose will not be reused.



29. Disconnect the electric throttle control connector from the throttle body.



30. Detach the quick release fuel hose from the driver side fuel rail and from the factory hard line near the fire wall. This hose will not be reused. **CAUTION:** Fuel may be under pressure, cover with rag to prevent fuel from spraying.



31. Unplug all eight (8) fuel injector connectors. Then use an 8mm socket to remove the ten (10) manifold bolts.

32. Unplug the MAP connector from the MAP sensor and the Active Runner Control connector from the back of the manifold.



33. Remove the brake booster hose from the back of the intake manifold.

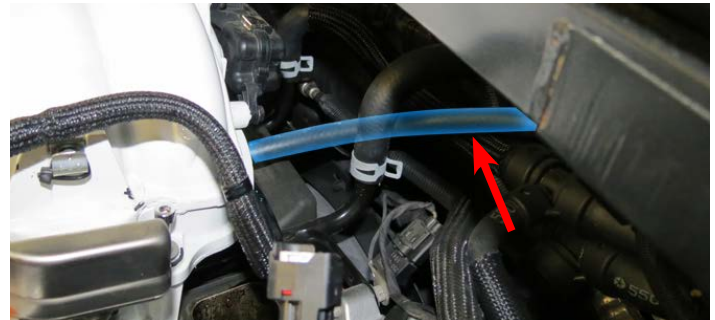

34. Carefully remove the intake manifold and set aside.

35. Use a soft cloth to clean the intake flange of the cylinder heads, using caution to make sure dirt or debris do not fall into the intake ports. Once the intake flanges are cleaned, cover the ports with protective tape to prevent any foreign objects from falling into the ports.



Installation Instructions

36. Using electrical tape, cover up the Active Runner Control connector to prevent any water from contacting the connector terminals.



37. Carefully remove and discard the plastic engine harness cover located at the passenger side front of the engine.



38. Using a 10mm socket, remove two (2) bolts securing each ignition coil. Remove the coils and note their order so that they can be reinstalled in the same order.

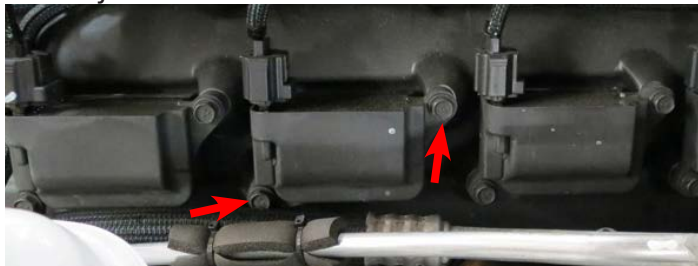

39. Using a 5/8" spark plug socket, remove all 16 spark plugs. Inspect and replace them as needed and gap to .028". Apply a small amount anti-seize to the threads of each plug and install. Torque each spark plug to 7.5-15 ft/lbs.

40. Reinstall the ignition coils in the same location they were originally and secure them with the stock bolts.

41. Use a 3/8" drive breaker bar to loosen the tension on the belt tensioner and remove the drive belt.

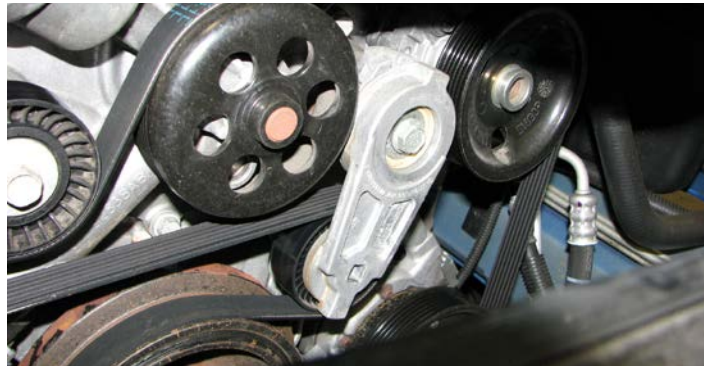

NOTE: Steps 42-66 are for removing the radiator and fan assembly to provide clearance for drilling and installing a pin between the crankshaft and harmonic balancer. The factory harmonic balancer is pressed onto the crankshaft and does not have a keyway. Without a pin installed between the crankshaft snout and balancer, the balancer can potentially "skip" on the crankshaft causing damage to both parts.

42. Disconnect the four (4) wires from the horns and remove the two (2) bolts securing the horns to the upper tie bar. Remove the horns and set aside. **NOTE:** Label the horns "DS" for driver side and "PS" for passenger side. Labeling will help with horn relocation later.



Installation Instructions

43. Using a panel puller, remove the passenger and driver side radiator shrouds. **NOTE:** Use a panel puller to detach the ambient temperature sensor from the driver side shroud prior to removing the shroud.



44. Using a panel puller, remove the horn harnesses from the upper tie bar.



45. Using a panel puller, remove the hood seal from the upper tie bar.



46. Remove the two (2) bolts securing the upper tie bar supports to the upper tie bar and disconnect the harness from the hood latch.



47. Remove the bolt securing the washer fluid tank to the upper tie bar.



48. Remove the bolt securing the A/C line bracket to the upper tie bar.



Installation Instructions

49. Using a panel puller, remove the overflow hose from the upper tie bar.

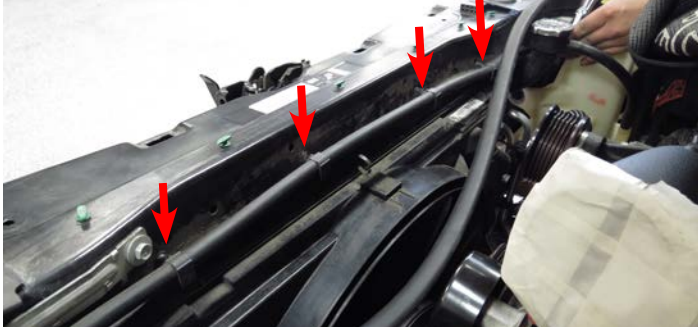

50. Using a panel puller, remove the four (4) push pins securing the driver side plastic cover to the upper tie bar.



51. Remove the three (3) driver side bolts securing the upper tie bar.



52. Remove the push pin securing the passenger side plastic cover to the upper tie bar. Remove the visible bolt securing the tie bar then lift up the plastic cover to expose the second bolt and remove the bolt.



53. Remove the upper tie bar and set aside.



54. Using hose clamp pliers, remove the two (2) clamps securing the upper radiator hose to the thermostat housing and radiator. Lift up on the clip securing the hose to the fan shroud and push the hose toward the engine. Remove the hose from the engine bay and set aside.



Installation Instructions

55. Place a drain pan under the lower hose on the passenger side of the radiator. Using hose clamp pliers, remove the hose clamp and hose from the radiator.



56. Remove the coolant bleed hose from the filler neck.



57. Disconnect the harness from the passenger side of the cooling fan and any hoses or wires attached to the fan shroud.



58. If equipped, use a panel puller to remove the two (2) push pins securing the power steering line and any other hoses or wires attached to the driver side of the fan shroud.

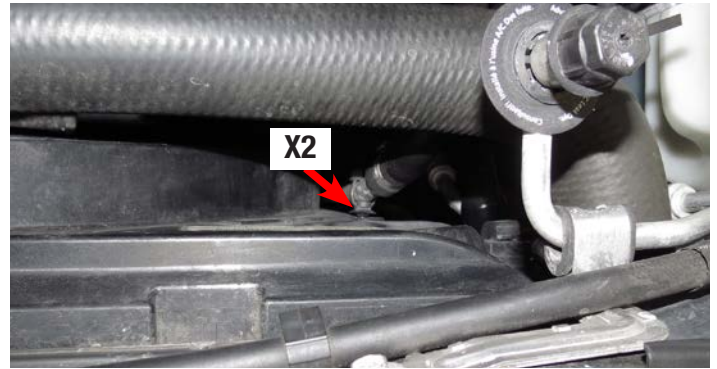

59. If equipped, undo the clip retaining the power steering lines to the driver side of the radiator. Close the empty clip to ensure the lines do not fall back into place.

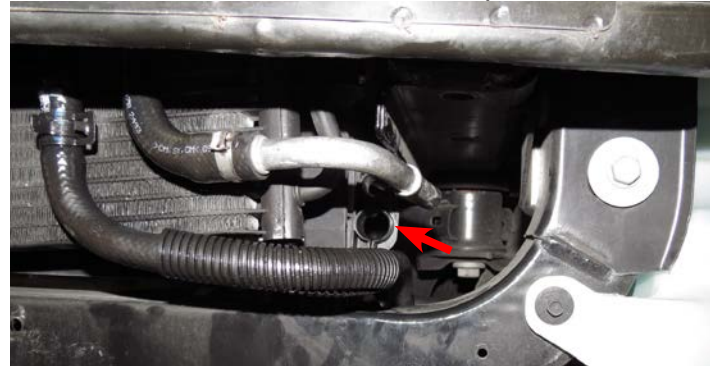

60. Separate the A/C condenser from the radiator by disengaging the clip on the driver side and carefully remove the radiator from the engine bay.



Installation Instructions

61. Using a 21mm socket and breaker bar, remove the factory crank bolt. Using the supplied crank bolt, install the drilling guide with the flat side facing outwards. Position drilling bushing in a comfortable position for drilling.



62. Mark the supplied drill bit 1.3" from the end of the tip with masking tape. Using the drilling bushing as a guide, drill into crank until the tape mark on the drill bit meets the drilling guide.



63. Use compressed air to clean out any debris present from the drilling. **CAUTION:** Use extreme caution when doing this to make sure debris does not get past the seal into the crankcase, as this will require a great deal of disassembly to correct or could cause severe engine damage if ignored.

64. Loosen the guide bolt and rotate the guide to line up the reaming hole with the hole drilled. Use the back of the supplied reamer to center the reaming hole to the drilled hole. Tighten down the crank bolt to secure the guide and ream the hole with the supplied reamer.

65. Remove the drilling guide and clean out the hole in the crank with compressed air. Apply Green Loctite (*Red Loctite can be used if Green Loctite is not available*) to the supplied crank pin and tap it into the hole in the crank.



66. Install an appropriate flywheel/flexplate holding tool to prevent the engine from turning. Using a 21mm socket, reinstall the factory crank bolt and torque to 127 ft/lbs. Remove the tool used to jam the flywheel and reinstall the dust cover if applicable.

67. Using a 16mm socket, remove the belt tensioner. **NOTE:** Tensioner must be removed to mount the supplied idler bracket.

NOTE: Step 68-71 are for vehicles with electronic power steering. Please disregard and proceed to Step 73 if your vehicle is equipped with a power steering pump.

68. Using a 13mm socket, remove the upper left bolt from the idler pulley assembly and the water pump bolt directly above the belt tensioner.



Installation Instructions

69. Using the short spacer and the bolts from Bag #2, loosely mount the idler bracket to the two bolt hole locations from the previous step. Using the long spacer and M6 x 110mm bolt from Bag #2, secure the bracket to the third bolt location; the provision on the cylinder head above the idler pulley bolt removed from Step 68. Torque all bolts to 21 ft/lbs.

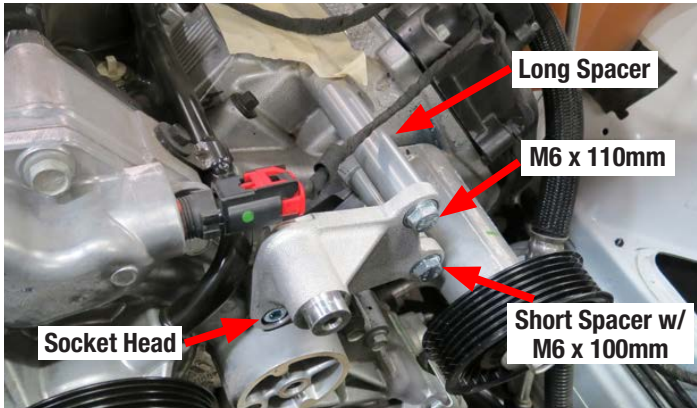

70. Using a 13mm socket, replace the grooved pulley on the factory idler bracket with the supplied 90mm grooved pulley. Make sure to apply Blue Loctite, or equivalent, to the threads of the factory bolt before installing. Torque bolt to 18 ft/lbs.

71. Using a 16mm socket, install the supplied upgraded belt tensioner using the factory bolt. Torque to 32 ft/lbs.

72. Install the supplied 76mm idler pulley to the idler bracket using the M8 x 25mm bolt and M8 washer from Bag #2. Make sure to apply Blue Loctite, or equivalent, to the threads of the bolt before installing. Torque bolt to 18 ft/lbs.



NOTE: Step 73-75 are for vehicles equipped with a power steering pump.

73. Using a 13mm socket, remove the upper left bolt from the power steering pump and the water pump bolt directly above the belt tensioner.

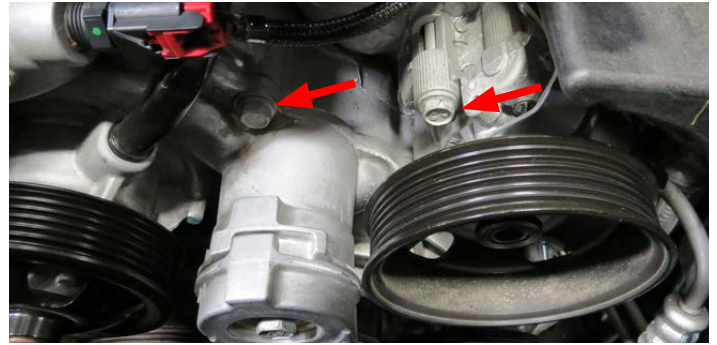

74. Mount the idler bracket to the location shown below using the long spacer and bolts from Bag #2. Torque bolts to 21 ft/lbs.

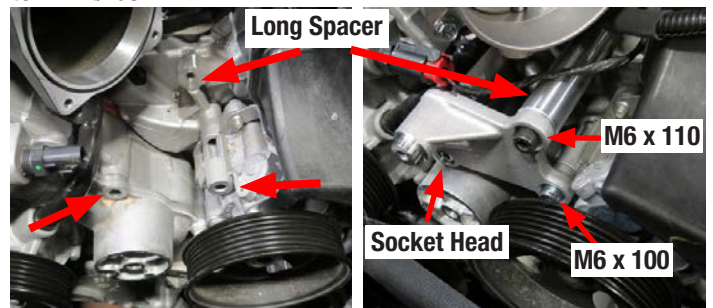

75. Using a 16mm socket, install the supplied upgraded belt tensioner using the factory bolt. Torque to 32 ft/lbs.

76. Using hose clamp pliers, remove the oil cooler hose and fitting from the front of the water pump. This hole will be plugged later with the provided 3/8" pipe plug after the cooling system is refilled.



Installation Instructions

77. Remove the factory thermostat housing and replace it with the provided housing. Secure the hose removed during step 76 to the new housing using the factory clamp.



78. Apply blue thread lock fluid onto the threads of the eight (8) M6 x 12mm SHCS bolts from the side cover kit and loosely screw on the side cover brackets to the underside of the supercharger lid.

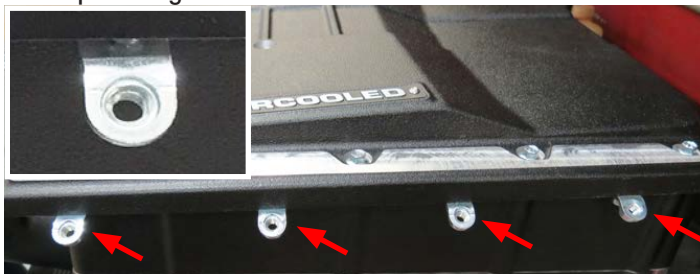

79. For proper bracket alignment, test fit the side covers onto the brackets using eight (8) M6 X 25mm bolts from the side cover kit. Align the side covers to the supercharger lid then fully tighten the bracket bolts. **Once all brackets are aligned and tightened, remove the side covers.**



80. Remove the tape covering the intake ports on the heads and inspect the area to ensure that no residue remains. Remove the plastic film from the supercharger ports if not already done so. Transfer the factory intake manifold gaskets to the supercharger runners.



81. With the help of an assistant, lift the supercharger into the engine bay. Use the intake bolt holes and injector bores to achieve the best alignment possible between the engine and the supercharger. **NOTE: Ensure that all eight (8) O-ring gaskets are in place before proceeding.**



82. Use a 10mm universal socket to install eight (8) M6 x 30mm intake manifold bolts from Bag #1 following the sequence shown below. Torque all bolts to 8 ft-lbs in the same order.

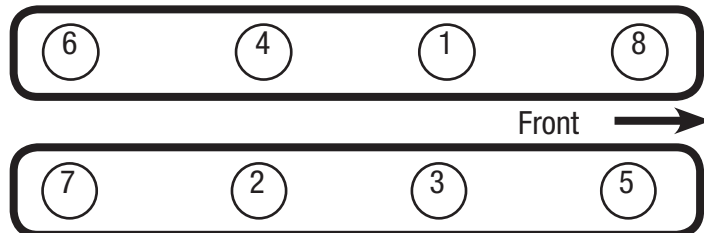

Installation Instructions

83. Install the supplied drive belt using the belt routing diagram below.

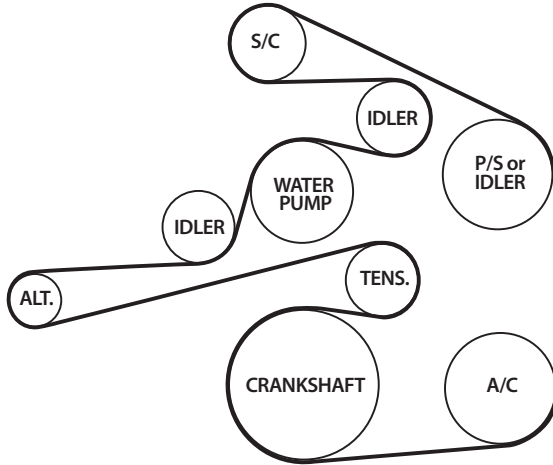

84. Apply silicone O-ring lube to the O-rings on the supplied fuel rail plug and crossover. Install the crossover to the front of the rails and install the plug into the rear provision of the passenger side rail as shown below. Tighten all fittings until the hex makes contact with the rail.

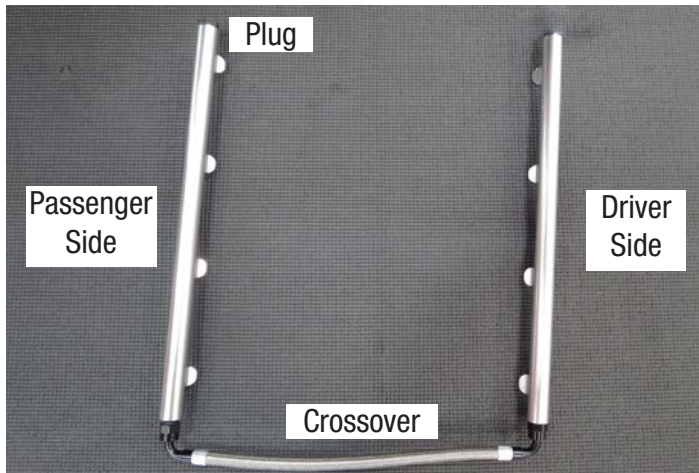

85. Apply silicone O-ring lube to the O-rings on the upper end (fuel inlet) of the provided fuel injectors, then install the provided fuel injector cups onto the upper end of the fuel injectors.

86. Apply silicone O-ring lube to the O-rings on the fuel injector cups, then install the injector/cup assembly into the fuel rails with the connectors oriented away from the rails.

87. Apply silicone O-ring lube to the lower O-rings on the fuel injectors, then install the fuel rails so the crossover is located at the front of the engine. Insert the injectors with cups into the provisions on the manifold and apply even pressure until the injectors and cups are fully seated.



88. Using a 10mm socket, secure the fuel rails to the manifold using four (4) M6 x 40mm bolts supplied in Bag #1 then reconnect all eight (8) fuel injector connectors using the provided USCAR to Minimeter adaptors.



89. Remove the oil fill cap from the stock intake manifold and install it on the supercharger.



Installation Instructions

90. Install the provided fuel input line from the factory hard line to the rear provision on the driver side fuel rail. Tighten the fitting until the hex makes contact with the rail.

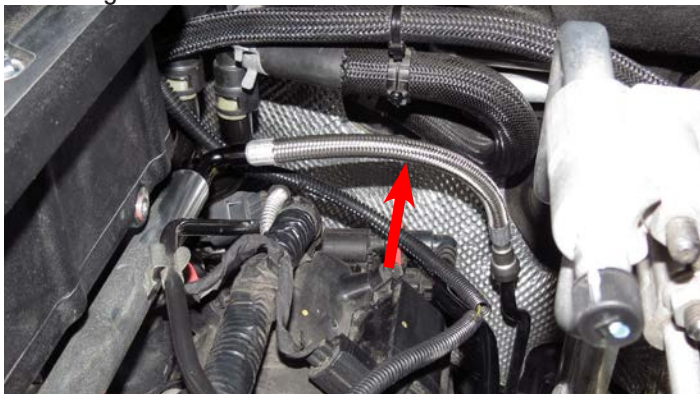

91. Attach the provided EVAP hose to the EVAP solenoid and route the hose along the driver side valve cover to the air inlet located on the supercharger nose drive. **NOTE:** It may be necessary to remove the EVAP solenoid from the bracket in order to push the new hose on. Apply silicone lube to the inside of the hose to ease installation.



92. Attach the provided PCV hose to the front fitting on the passenger side of the air inlet and then to the PCV fitting on the supercharger as shown.



93. Install the provided brake booster hose and straight connector to the end of the factory hose at the back of the supercharger. Route the hose along the passenger side valve cover and connect to the rear barb on the manifold as shown.



94. Reinstall the radiator and fan assembly by reversing steps 43-66, then continue with the remainder of this installation guide. **NOTE:** Do not reinstall horns at this time.

95. Attach the water pump to the water pump bracket by sliding the rubber isolator over the pump motor then onto the bracket. Orient the pump as shown below. **NOTE:** Apply a small amount of silicone lube inside the rubber isolator for easier installation and pump orientation adjustments.

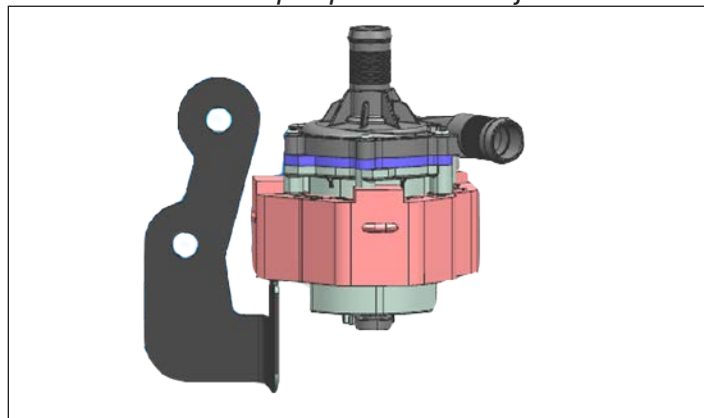

Installation Instructions

96. Mount the water pump/bracket assembly to the passenger side frame using the factory bolts.

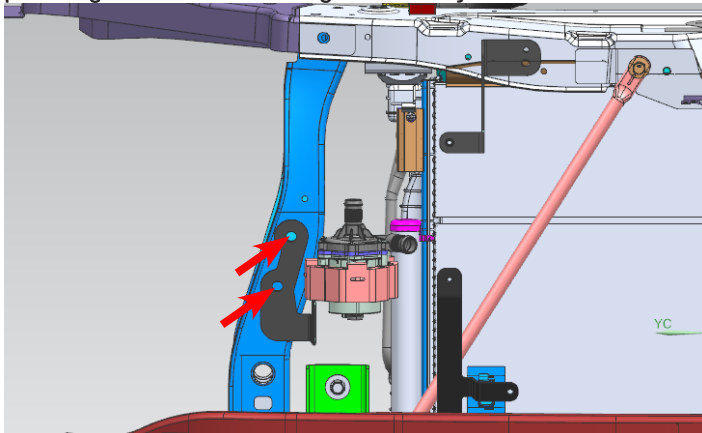

97. Loosely secure the two (2) upper LTR brackets to the tie bar using the factory horn locations and factory bolts. **NOTE: Use the bottom hole on the brackets.**

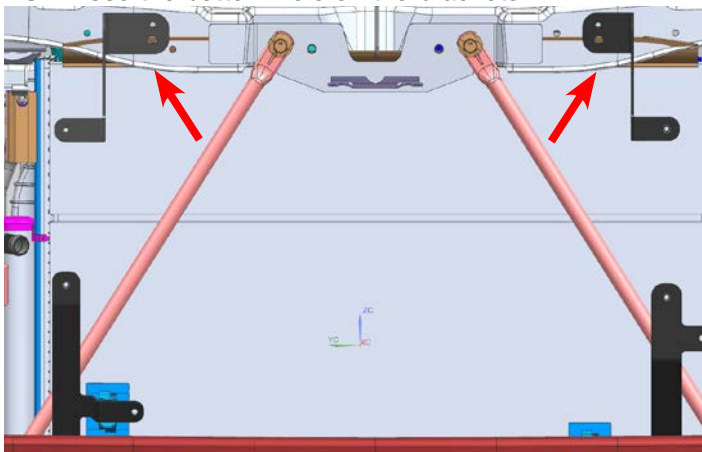

98. Loosely secure the two (2) lower LTR brackets to the crash beam using the factory mounting locations and hardware for the tie bar supports. **NOTE: The support bars should be mounted on top of the LTR brackets.**

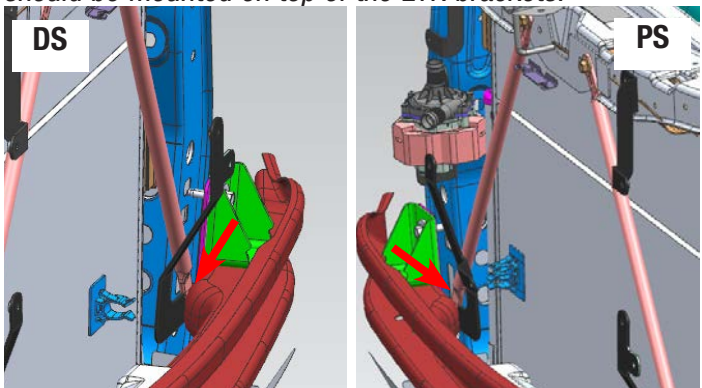

99. Position the low temperature radiator (LTR) in front of the AC condenser with the inlet and outlet pointing toward the passenger side of the vehicle. Line up the mounting holes on the LTR with the holes on the brackets installed during steps 96 & 97. Secure the LTR to the brackets with the provided M6 x 16mm bolts from Bag #3.



100. Tighten all eight (8) bolts securing the LTR and brackets making sure the LTR is centered and level with the ground.

101. Using the factory coil bolts, mount the intercooler reservoir bracket between the second and third coil on the passenger side.

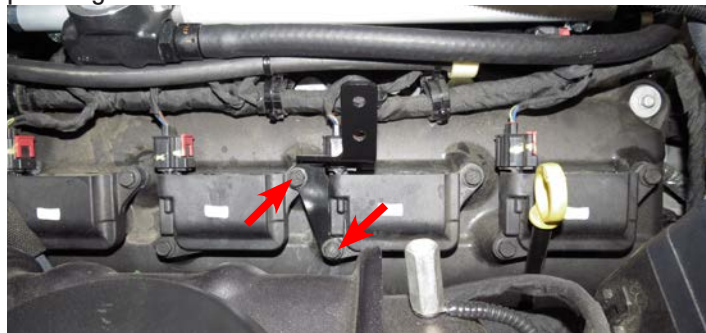

102. Attach the intercooler reservoir to the bracket using the two M6 x 10mm bolts supplied in Bag #3.



Installation Instructions

103. Install the Reservoir to Water Pump hose to the front provision of the intercooler reservoir and secure it with a 3/8" hose clamp from Bag #3. Route the hose down to the water pump inlet and secure it with a hose clamp.



104. Install the Manifold to Tank hose between the supercharger and tank. Secure both ends of the hose with 3/8" hose clamps from Bag #3.



105. Test fit the passenger side radiator shroud and mark the center location where the water pump outlet contacts the shroud. Use a 1-1/2" hole saw to bore a hole in the shroud for intercooler hose clearance and reinstall the shroud.



106. Install the Water Pump to LTR hose from the water pump to the top fitting on the LTR and secure both ends with a 3/8" hose clamp from Bag #3.



107. Install the LTR to Manifold hose onto the driver side intercooler fitting and secure with a 3/8" hose clamp from Bag #3.

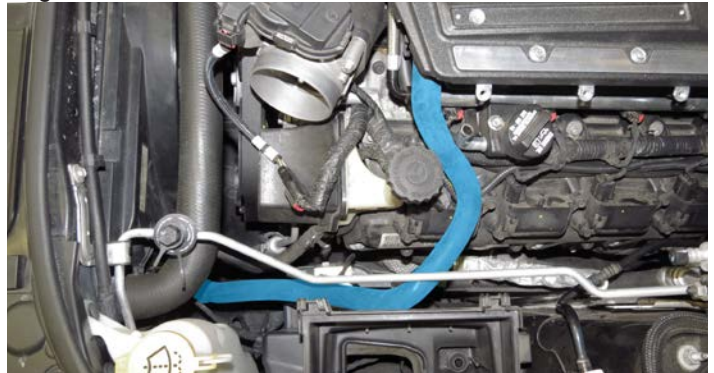

108. Route the hose installed during the previous step through the gap between the radiator and the frame. **NOTE:** Use caution when routing the hose to ensure it will not contact sharp edges or drive belt and pulleys.



Installation Instructions

109. Using an appropriate cutting tool, trim a notch in the driver side radiator shroud so the intercooler hose rests against the LTR mounting bracket without contacting the shroud.

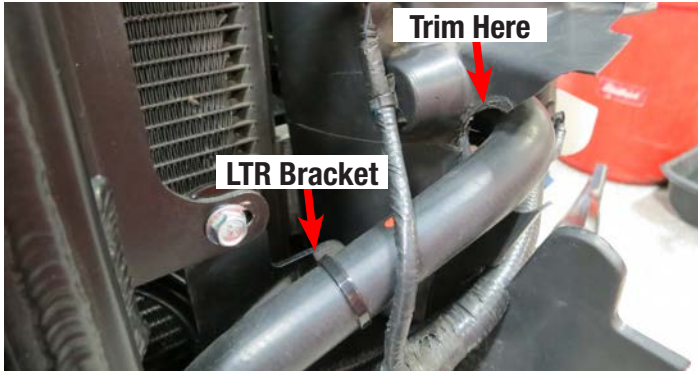

110. Route the remainder of the LTR to Manifold hose under the LTR and secure to the bottom fitting using one (1) 3/8" clamp from bag #3. Using the two (2) provided Zip Tie Anchors, secure the hose to the bottom two LTR brackets using the anchor holes on the bracket.

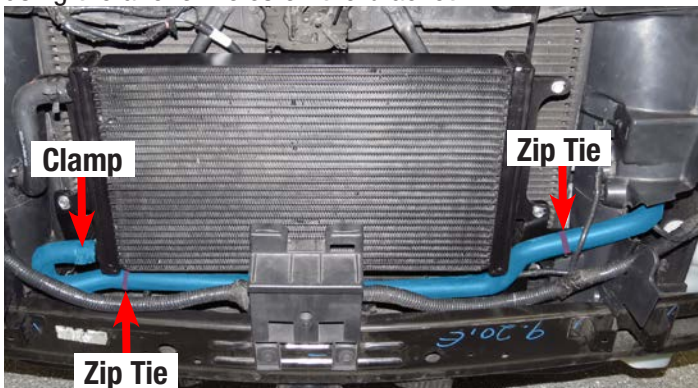

111. Attach protective convolute (included) around any LTR hoses that make contact with metal objects or sharp objects. Secure the convolute with zip ties or electrical tape.

Note: Steps 112 & 117 are for relocating the horns to the Lane Departure Sensor Bracket located under the center of the front crash beam. Use the photo below as a guide for how the new horn mounting locations should look.



112. Remove the bolt on the Driver Side of the lane departure sensor bracket. Locate the original Passenger Side horn and loosen the nut that attaches the horn mounting bracket to the horn body.

113. Relocate the Passenger Side horn to the Driver Side of the lane departure sensor bracket using the factory bolt. Orient the horn as shown in the above photo, then tighten the nut securing the mounting bracket to the horn body.

114. Remove the bolt on the Passenger Side of the lane departure sensor bracket. Locate the original Driver Side horn and loosen the nut that attaches the horn mounting bracket to the horn body.

115. Relocate the Driver Side horn to the Passenger Side of the lane departure sensor bracket using the factory bolt. Orient the horn as shown in the above photo, then tighten the nut securing the mounting bracket to the horn body.

116. Reconnect the factory Driver Side horn harness to the horn located on the Drive Side of the lane departure sensor bracket.

Installation Instructions

117. Connect the provided horn extension harness to factory passenger side horn harness, then route the extension harness down to the horn located on the passenger side of the lane departure bracket. Connect the horn extension to the horn and secure the harness away from any sharp objects.

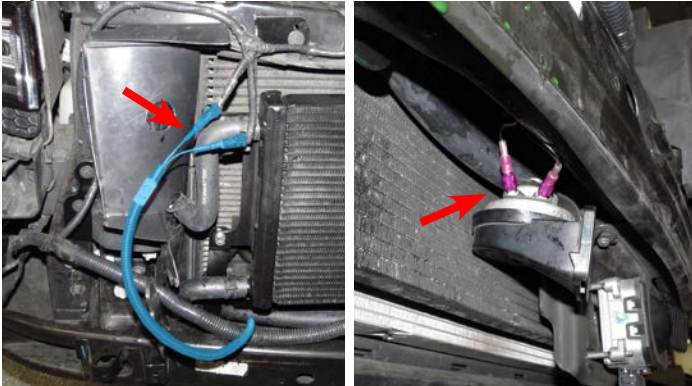

118. Use an 8mm socket to remove the throttle body from the stock manifold. In the orientation shown below, install the throttle body on the supercharger manifold using the supplied paper gasket and four (4) M6 x 40mm bolts from Bag #1.



NOTE: When installing the stock 80mm throttle body, use RTV silicone to fill the two (2) holes at the top of the throttle body mounting surface and apply the provided gasket. Note the gasket orientation shown below.

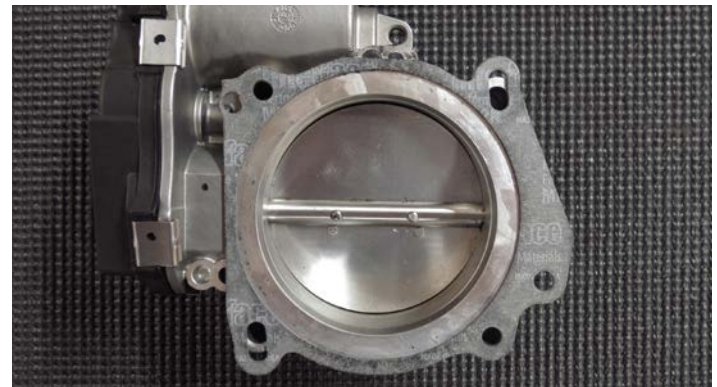

119. Reconnect the factory throttle body connector to the throttle body using the provided ETC Extension harness. Secure the harness away from the drive belt.



Installation Instructions

120. Replace the factory air filter with the supplied green air filter, then reinstall the factory airbox cover and air inlet tube.



NOTE: The IAT sensor should be removed and the hole plugged with the included plastic plug.



121. Install the provided driver side PCV hose onto the fitting next to the oil fill cap and then to the PCV fitting on the airbox.

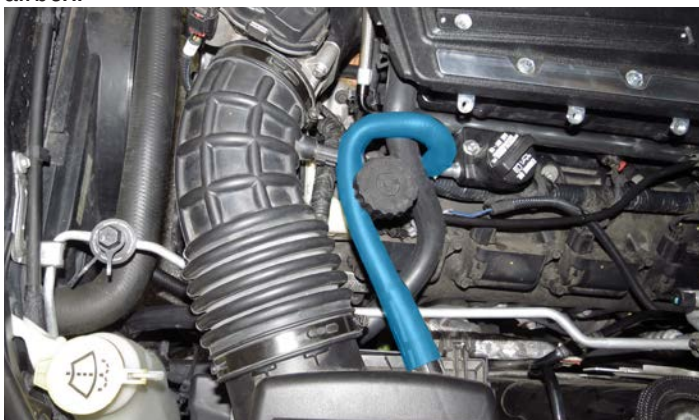

122. Connect the supplied MAP extension harness onto the factory MAP connector, then connect the MAP extension harness to the MAP sensor located on the rear driver side of the manifold.



123. Connect the IAT extension harness to the stock IAT connector. Route the IAT extension harness behind the manifold and connect to the IAT sensor located on the rear passenger side of the manifold.



124. Open the fuse box and remove the fuse from location F66 - (See reverse of fuse box cover). Install that fuse in the bottom slot of the provided fuse tap and the included 10 amp fuse in the top slot. Install the fuse tap in the slot previously occupied by the stock fuse.

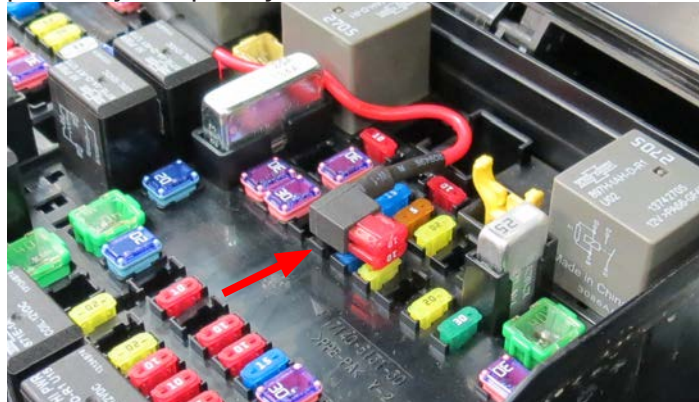

125. Feed the bare wire extending from the water pump harness through the opening on the left rear corner of the fuse box and insert it into the butt connector on the fuse tap. Crimp the butt connector firmly to secure the connection.



126. Secure the water pump harness ground (-) wire under the negative battery jumper terminal located next to the fuse box. Remove the terminal, slide the ring connector over the stud and reinstall the terminal.



127. Mount the water pump harness relay under the factory bolt located next to the ECM. Remove the bolt, slide the ring connector onto the bolt and reinstall.



128. Route the Power (+) wire on the water pump harness over to the power stud on the fuse box. Remove the nut, slide the ring connector over the stud and reinstall the nut.



129. Route the water pump connector down to the electric water pump and connect it to the water pump.

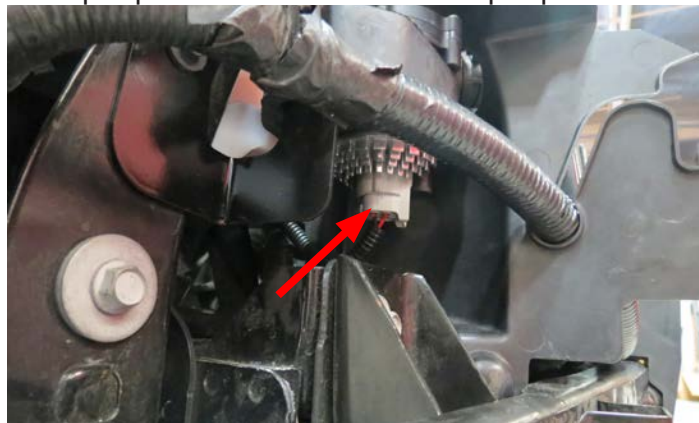

Installation Instructions

130. Secure all water pump harness wires and the fuse holder away from any moving parts or sharp objects.

131. Remove the intercooler reservoir cap and fill the system with a 50/50 blend of water and antifreeze. **Please refer to “How to Prime the Edelbrock E-Force Intercooler System” on page #30.**

132. Fill the cooling system with appropriate 50/50 blend of coolant until coolant leaks out of the bleeder hole. Immediately install the provided 3/8” pipe plug. Continue filling the coolant reservoir until the level reaches the Cold Fill level.



133. Reinstall the front fascia and wheels by reversing steps 16-23.

134. Reconnect the Positive (+) battery terminal.

135. Turn the ignition on but do not start the vehicle. Check for any fuel, coolant or power steering fluid leaks (if applicable). If leaks are present, shut the ignition off immediately and repair leaks before continuing.

136. Start the engine and let the it come up to operating temperature, then shut it off and recheck all fluid levels. Top fluids off if necessary.

137. Before installing the side covers onto the supercharger, install the four (4) M6 x 8mm bolts from the side cover hardware kit to the lower holes on each cover.



138. Using the eight (8) M6 x 25mm bolts from the side cover kit, secure the side covers to the brackets previously installed during steps 78 & 79.



Congratulations on the successful installation of your new Edelbrock E-Force Supercharger System. If you have any questions, please call our Technical Support hotline at 800-416-8628 and one of our technicians will be happy to assist you.

How to Prime the Edelbrock E-Force Intercooler Systems.



The electric water pump used on this Edelbrock E-Force Supercharger System has a built-in micro-processor that will vary pump cycle speed when air bubbles are present in the system. If a significant amount of air is trapped in the system, the pump may cycle at a slower speed and pulsations are likely to occur resulting in poor cooling performance.

For the best result, it is highly recommended to use a Radiator Cooling System Vacuum Purge and Refill Kit to properly evacuate the air from the intercooler system before filling with a 50/50 mixture of coolant and distilled water. If one is not available, the following procedure will be adequate.

1. Using the Lisle 24680 Spill-Free Funnel, or equivalent, secure the appropriate filler neck adapter to the surge tank.
2. Attach the funnel and fill with a 50/50 mixture of coolant and distilled water until the funnel is half full.
3. Turn the ignition to the ON position and listen for the pump's electric motor to cycle. Air bubbles will begin to purge from the system as the coolant level drops. Add coolant to the funnel as necessary. *NOTE: Do NOT let the coolant level in the funnel run empty as this may introduce air into the system.*
4. To build more pressure in the intercooler system, try squeezing the intercooler hoses while the pump is cycling. Building pressure in the system will help purge the trapped air from the intercooler system.
5. Cycle the ignition OFF and wait a few seconds for the pump to come to a stop.
6. Cycle the ignition ON again and repeat until the sound of the electric pump is continuous without any pulsation. *NOTE: During water pump start-up, it is normal for a slight pulsation to occur. Once the pump has reached its maximum cycle speed, no pulsations should be present.*
7. Periodically inspect the water pump flow after a few drive cycles and re-fill the intercooler system as necessary.
8. Several drive cycles may be required to completely purge the air from the intercooler system. During a drive cycle, the intercooler system will build up pressure as the supercharger temperature increases. Any residual air trapped in the system will gradually bleed out of the surge tank as the system reaches a pressure above 5psi.

WARNING: Always avoid removing the surge tank cap when the engine is hot. The hot coolant is under pressure and may spray out causing burns.